

ICC-ES Evaluation Report

ESR-3260

Reissued November 2023

This report also contains:

- LABC Supplement

Subject to renewal November 2024

ICC-ES Evaluation Reports are not to be construed as representing aesthetics or any other attributes not specifically addressed, nor are they to be construed as an endorsement of the subject of the report or a recommendation for its use. There is no warranty by ICC Evaluation Service, LLC, express or implied, as to any finding or other matter in this report, or as to any product covered by the report.

Copyright © 2023 ICC Evaluation Service, LLC. All rights reserved.

<p>DIVISION: 03 00 00— CONCRETE</p> <p>Section: 03 16 00— Concrete Anchors</p> <p>DIVISION: 05 00 00— METALS</p> <p>Section: 05 05 19— Post-Installed Concrete Anchors</p>	<p>REPORT HOLDER: DEWALT</p>	<p>EVALUATION SUBJECT: POWER-BOLT®+ HEAVY DUTY SLEEVE ANCHORS FOR CRACKED AND UNCRACKED CONCRETE (DEWALT)</p>	
--	---	--	---

1.0 EVALUATION SCOPE

Compliance with the following codes:

- 2021, 2018, 2015, and 2012 [International Building Code® \(IBC\)](#)
- 2021, 2018, 2015, and 2012 [International Residential Code® \(IRC\)](#)

For evaluation for compliance with codes adopted by the [Los Angeles Department of Building and Safety \(LADBS\)](#), see [ESR-3260 LABC and LARC Supplement](#).

Property evaluated:

- Structural

2.0 USES

The Power-Bolt+ Heavy Duty Sleeve Anchors are used as anchorage to resist static, wind and seismic tension and shear loads in cracked and uncracked normal-weight concrete and lightweight concrete having a specified compressive strength, f'_c , of 2,500 psi to 8,500 psi (17.2 MPa to 58.6 MPa).

The Power-Bolt+ sleeve anchors comply with Section 1901.3 of the 2021, 2018 and 2015 IBC, and Section 1909 of the 2012 IBC. The anchors are alternatives to cast-in-place anchors described in Section 1908 of the 2012 IBC. The anchors may also be used where an engineered design is submitted in accordance with Section R301.1.3 of the IRC.

3.0 DESCRIPTION

3.1 Power-Bolt+:

Power-Bolt+ Heavy Duty Sleeve Anchors are torque-controlled, mechanical expansion anchors comprised of a high strength steel bolt, matching steel washer, steel cone, steel expansion wedge (clip), steel sleeve, plastic compression ring and plastic retention nut. Available diameters are 1/2 inch, 5/8 inch and 3/4 inch (12.7 mm, 15.9 mm and 19.1 mm). The steel bolt, expansion clip, sleeve and cone are manufactured from medium carbon steel complying with requirements set forth in the approved quality documentation, and have a minimum 0.0002-inch-thick (5 µm) zinc plating in accordance with ASTM B633. The steel washers comply with ASTM F844. The Power-Bolt+ Heavy Duty Sleeve Anchor is illustrated in [Figure 2](#). The anchor is assembled such

that the cone is able to enter the bottom of the tri-segmented expansion clip, which freely rotates around the bolt. The expansion clip longitudinal movement is restrained by the compression ring and sleeve. The anchors are installed in a predrilled hole with a hammer. When torque is applied to the head of the installed anchor bolt, the cone at the other end of the anchor is drawn into the expansion clip, forcing it outward into the sides of the predrilled hole in the base material.

3.2 Concrete:

Normal-weight and lightweight concrete must conform to Sections 1903 and 1905 of the IBC, as applicable.

4.0 DESIGN AND INSTALLATION

4.1 Strength Design:

4.1.1 General: Design strength of anchors complying with the 2021 IBC, as well as Section R301.1.3 of the 2021 IRC must be determined in accordance with ACI 318-19 Chapter 17 and this report.

Design strength of anchors complying with the 2018 and 2015 IBC, as well as Section R301.1.3 of the IRC, must be determined in accordance with ACI 318-14 Chapter 17 and this report.

Design strength of anchors complying with the 2012 IBC, as well as Section R301.1.3 of the 2012 IRC, must be determined in accordance with ACI 318-11 Appendix D and this report.

A design example according to the 2021, 2018, 2015 and 2012 IBC is given in [Table 5](#) of this report.

Design parameters provided in [Tables 1, 4](#) and [5](#) and references to ACI 318 are based on the 2021 IBC (ACI 318-19), 2018 and 2015 IBC (ACI 318-14) and on the 2012 IBC (ACI 318-11) unless noted otherwise in Sections 4.1.1 through 4.1.12 of this report. The strength design of anchors must comply with ACI 318-19 17.5.1.2, ACI 318-14 Section 17.3.1 or ACI 318-11 Appendix D Section D.4.1, as applicable, except as required in ACI 318-19 17.10, ACI 318-14 17.2.3 or ACI 318 D.3.3, as applicable. Strength reduction factors, ϕ , as given in ACI 318-19 17.5.3, ACI 318-14 17.3.3 or ACI 318-11 D.4.3, as applicable, and noted in [Tables 4](#) and [5](#) of this report, must be used for load combinations calculated in accordance with Section 1605.1 of the 2021 IBC or Section 1605.2.1 of the 2018, 2015 and 2012 IBC, ACI 318 (-19 or -14) 5.3 or ACI 318-11 9.2, as applicable. Strength reduction factors, ϕ , described in ACI 318-11 D.4.4 must be used for load combinations calculated in accordance with ACI 318-11 Appendix C. Strength reduction factors, ϕ , corresponding to ductile steel elements are appropriate, except for the $3/4$ -inch-diameter which is considered a brittle steel element.

4.1.2 Requirements for Static Steel Strength in Tension, N_{sa} : The nominal static steel strength of a single anchor in tension, N_{sa} , calculated in accordance with ACI 318-19 17.6.1.2, ACI 318-14 17.4.1.2 or ACI 318-11 D.5.1.2, as applicable, is given in [Table 3](#) of this report.

4.1.3 Requirements for Static Concrete Breakout Strength in Tension, N_{cb} or N_{cbg} : The nominal concrete breakout strength of a single anchor or a group of anchors in tension, N_{cb} and N_{cbg} , respectively must be calculated in accordance with ACI 318-19 17.6.2, ACI 318-14 17.4.2 or ACI 318-11 D.5.2, as applicable, with modifications as described in this section. The basic concrete breakout strength in tension, N_b , must be calculated in accordance with ACI 318-19 17.6.2.2, ACI 318-14 17.4.2.2 or ACI 318-11 D.5.2.2, as applicable, using the values of h_{ef} and k_{cr} as given in [Table 3](#) of this report. The nominal concrete breakout strength in tension in regions where analysis indicates no cracking in accordance with ACI 318-19 17.6.2.5, ACI 318-14 17.4.2.6 or ACI 318-11 D.5.2.6, as applicable, must be calculated with the value of k_{uncr} as given in [Table 3](#) and with $\psi_{c,N} = 1.0$.

4.1.4 Requirements for Static Pullout Strength in Tension, N_{pn} : Since there are no values for $N_{p,cr}$ or $N_{p,uncr}$ provided in [Table 3](#) of this report, the pullout strength in tension does not govern and need not be evaluated.

4.1.5 Requirements for Static Steel Strength in Shear, V_{sa} : The nominal steel strength in shear, V_{sa} , of a single anchor in accordance with ACI 318-19 17.7.1.2, ACI 318-14 17.5.1.2 or ACI 318-11 D.6.1.2, as applicable, is given in [Table 4](#) of this report and must be used in lieu of the values derived by calculation from ACI 318-19 Eq. 17.7.1.2b, ACI 318-14 Eq. 17.5.1.2b or ACI 318-11, Eq. D-29, as applicable.

4.1.6 Requirements for Static Concrete Breakout Strength in Shear, V_{cb} or V_{cbg} : The nominal concrete breakout strength of a single anchor or group of anchors in shear, V_{cb} or V_{cbg} , respectively, must be calculated in accordance with ACI 318-19 17.7.2, ACI 318-14 17.5.2 or ACI 318-11 D.6.2, as applicable, with modifications as described in this section. The basic concrete breakout strength in shear, V_b , must be calculated in accordance with ACI 318-19 17.7.2.2.1, ACI 318-14 17.5.2.2 or ACI 318-11 D.6.2.2, as applicable, using the values of l_e and d_a given in [Table 4](#) of this report.

4.1.7 Requirements for Static Concrete Pryout Strength in Shear, V_{cp} or V_{cpg} : The nominal concrete pryout strength of a single anchor or group of anchors, V_{cp} or V_{cpg} , respectively, must be calculated in accordance with ACI 318-19 17.7.3, ACI 318-14 17.5.3 or ACI 318-11 D.6.3, as applicable, modified by using the value of k_{cp} provided in [Table 4](#) and the value of N_{cb} or N_{cbg} as calculated in Section 4.1.3 of this report.

4.1.8 Requirements for Seismic Design:

4.1.8.1 General: For load combinations including seismic loads, the design must be performed in accordance with ACI 318-19 17.10, ACI 318-14 17.2.3 or ACI 318-11 D.3.3, as applicable. Modifications to ACI 318-19 17.10, ACI 318-14 17.2.3 shall be applied under Section 1905.1.8 of the 2021, 2018 and 2015 IBC. For the 2012 IBC, Section 1905.1.9 is omitted.

The nominal steel strength and nominal concrete breakout strength for anchors in tension, and the nominal concrete breakout strength and pryout strength for anchors in shear, must be calculated in accordance with ACI 318-19 17.6 and 17.7, ACI 318-14 17.4 and 17.5 or ACI 318-11 D.5 and D.6, respectively, taking into account the corresponding values in [Tables 4](#) and [5](#) of this report.

The 1/2-inch and 5/8-inch (12.7 mm and 15.9 mm) anchors comply with ACI 318 (-19 or -14) 2.3 or ACI 318-11 D.1, as applicable, as ductile steel elements and the 3/4-inch (19.1 mm) are considered brittle steel elements; anchors must be designed in accordance with ACI 318-19 17.10.4, 17.10.5, 17.10.6, and 17.10.7; ACI 318-14 17.2.3.4, 17.2.3.5, 17.2.3.6 and 17.2.3.7; or ACI 318-11 D.3.3.4, D.3.3.5, D.3.3.6 and D.3.3.7, as applicable. Strength reduction factors, ϕ , are given in [Table 3](#) and [Table 4](#).

The anchors may be installed in concrete structures assigned to Seismic Design Categories (SDCs) A through F.

4.1.8.2 Seismic Tension: The nominal steel strength and nominal concrete breakout strength for anchors in tension must be calculated in accordance with ACI 318-19 17.6.1 and 17.6.2, ACI 318-14 17.4.1 and 17.4.2 or ACI 318-11 D.5.1 and D.5.2, as applicable, respectively, as described in Sections 4.1.2 and 4.1.3 of this report. Since there are no values for $N_{p,eq}$ provided in [Table 3](#) of this report, the pullout strength in tension for seismic loads need not be evaluated in accordance with ACI 318-19 17.6.3.2.1, ACI 318-14 17.4.3.2 or ACI 318-11 D.5.3.2, as applicable.

4.1.8.3 Seismic Shear: The nominal concrete breakout strength and pryout strength for anchors in shear must be calculated according to ACI 318-19 17.7.2 and 17.7.3, ACI 318-14 17.5.2 and 17.5.3, or ACI 318-11 D.6.2 and D.6.3, as applicable, respectively, as described in Sections 4.1.6 and 4.1.7. In accordance with ACI 318-19 17.7.1.2, ACI 318-14 17.5.1.2 or ACI 318-11 D.6.1.2, as applicable, the appropriate value for nominal steel strength in shear for seismic loads, $V_{sa,eq}$, described in [Table 4](#) of this report must be used in lieu of V_{sa} .

4.1.9 Requirements for Interaction of Tensile and Shear Forces: Anchors or groups of anchors that are subject to the effects of combined axial (tensile) and shear forces must be designed in accordance with ACI 318-19 17.8, ACI 318-14 17.6 or ACI 318-11 D.7, as applicable.

4.1.10 Requirements for Critical Edge Distance: In applications where $c < c_{ac}$ and supplemental reinforcement to control splitting of the concrete is not present, the concrete breakout strength in tension for uncracked concrete, calculated according to ACI 318-19 17.6.2, ACI 318-14 17.4.2 or ACI 318-11 D.5.2, as applicable, must be further multiplied by the factor $\psi_{cp,N}$ given by Eq-3:

$$\psi_{cp,N} = \frac{c}{c_{ac}} \quad (\text{Eq-3})$$

where the factor $\psi_{cp,N}$ need not be taken as less than $\frac{1.5h_{ef}}{c_{ac}}$. For all other cases, $\psi_{cp,N} = 1.0$. In lieu of using ACI 318-19 17.9.5, ACI 318-14 17.7.6 or ACI 318-11 D.8.6, values of c_{ac} must comply with [Table 3](#).

4.1.11 Requirements for Minimum Member Thickness, Minimum Anchor Spacing and Minimum Edge Distance: In lieu of ACI 318-19 17.9.2, ACI 318-14 17.7.1 and 17.7.3 or ACI 318-11 D.8.1 and D.8.3, respectively, as applicable, values of c_{min} and s_{min} must comply with [Table 1](#) of this report. In lieu of ACI 318-19 17.9.4, ACI 318-14 17.7.5, or ACI 318-11 D.8.5, as applicable, minimum member thicknesses, h_{min} , must comply with [Table 1](#).

4.1.12 Lightweight Concrete: For the use of anchors in lightweight concrete, the modification factor λ_a equal to 0.8 λ is applied to all values of $\sqrt{f'_c}$ affecting N_n and V_n .

For ACI 318-19 (2021 IBC), ACI 318-14 (2018 and 2015 IBC), and ACI 318-11 (2012 IBC), λ shall be determined in accordance with the corresponding version of ACI 318.

4.2 Allowable Stress Design (ASD):

4.2.1 General: Design values for use with allowable stress design (working stress design) load combinations in accordance with Section 1605.1 of the 2021 IBC or Section 1605.3 of the 2018, 2015 and 2012 IBC are required, these are calculated using Eq-4 and Eq-5 as follow:

$$T_{allowable,ASD} = \frac{\phi N_n}{\alpha} \quad (\text{Eq-4})$$

$$V_{allowable,ASD} = \frac{\phi V_n}{\alpha} \quad (\text{Eq-5})$$

where:

$T_{allowable,ASD}$ = Allowable tension load (lbf or kN)

$V_{allowable,ASD}$ = Allowable shear load (lbf or kN)

ϕN_n = Lowest design strength of an anchor or anchor group in tension as determined in accordance with ACI 318 (-19 or -14) Chapter 17 and 2021, 2018 and 2015 IBC Section 1905.1.8, ACI 318-11 Appendix D, and Section 4.1 of this report, as applicable (lbf or N). For the 2012 IBC, Section 1905.1.9 shall be omitted.

ϕV_n = Lowest design strength of an anchor or anchor group in shear as determined in accordance with ACI 318 (-19 or -14) Chapter 17 and 2021, 2018 and 2015 IBC Section 1905.1.8, ACI 318-11 Appendix D, and Section 4.1 of this report, as applicable (lbf or N). For the 2012 IBC, Section 1905.1.9 shall be omitted.

α = Conversion factor calculated as a weighted average of the load factors for the controlling load combination. In addition, α must include all applicable factors to account for nonductile failure modes and required over-strength.

The requirements for member thickness, edge distance and spacing, described in this report, must apply. An example of allowable stress design values for illustrative purposes is shown in [Table 5](#) of this report.

4.2.2 Interaction of Tensile and Shear Forces: The interaction must be calculated and consistent with ACI 318-19 17.8, ACI 318-14 17.6 or ACI 318-11 D.7, as applicable, as follows:

For shear loads $V \leq 0.2V_{allowable,ASD}$, the full allowable load in tension must be permitted.

For tension loads $T \leq 0.2T_{allowable,ASD}$, the full allowable load in shear must be permitted.

For all other cases Eq-6 applies:

$$\frac{T}{T_{allowable,ASD}} + \frac{V}{V_{allowable,ASD}} \leq 1.2 \quad (\text{Eq-6})$$

4.3 Installation:

Installation parameters are provided in [Table 1](#) and [Figure 1](#). Anchor locations must comply with this report and the plans and specifications approved by the code official. The Power-Bolt+ heavy duty sleeve anchors must be installed in accordance with the manufacturer's published installation instructions as shown in [Figure 3](#) of this report. Anchors must be installed in holes drilled into the concrete using carbide-tipped masonry drill bits complying with ANSI B212.15. The nominal drill bit diameter must be equal to that of the anchor. The minimum drilled hole depth is given in [Table 1](#). Prior to anchor installation, the dust and debris must be removed from the predrilled hole using a hand pump, compressed air or a vacuum. The anchor must be hammered into the predrilled hole until the proper nominal embedment depth is achieved. The bolt must be tightened until the torque values, T_{inst} , specified in [Table 1](#) of this report are achieved.

4.4 Special Inspection:

Periodic special inspection is required in accordance with Section 1705.1.1 and Table 1705.3 of the 2021, 2018, 2015 and 2012 IBC, as applicable. The special inspector must make periodic inspections during anchor installation to verify anchor type, anchor dimensions, concrete type, concrete compressive strength, drill bit type, hole dimensions, hole cleaning procedure, concrete member thickness, anchor embedment, anchor spacing, edge distances, tightening torque and adherence to the manufacturer's published installation instructions. The special inspector must be present as often as required in accordance with the "Statement of Special Inspection".

5.0 CONDITIONS OF USE:

The Power-Bolt+ Heavy Duty Sleeve Anchors described in this report comply with, or are suitable alternatives to what is specified in, those codes listed in Section 1.0 of this report, subject to the following conditions:

- 5.1 The anchors must be installed in accordance with the manufacturer's published installation instructions, the approved plans and this report. In case of a conflict, the most restrictive requirement governs.
- 5.2 Anchor sizes, dimensions, and minimum embedment depths are as set forth in this report.
- 5.3 Anchors must be installed in cracked and uncracked normal-weight concrete and lightweight concrete having a specified compressive strength, f'_c , of 2,500 psi to 8,500 psi (17.2 MPa to 58.6 MPa).
- 5.4 The values of f'_c used for calculation purposes must not exceed 8,000 psi (55.2 MPa).

- 5.5 The concrete shall have attained its minimum design strength prior to installation of the anchors.
- 5.6 Strength design values must be established in accordance with Section 4.1 of this report.
- 5.7 Allowable stress design values must be established in accordance with Section 4.2 of this report.
- 5.8 Anchor spacing(s) and edge distance(s), as well as minimum member thickness, must comply with [Table 1](#) of this report, unless otherwise noted in the approved plans.
- 5.9 Prior to installation, calculations and details demonstrating compliance with this report must be submitted to the code official. The calculations and details must be prepared by a registered design professional where required by the statutes of the jurisdiction in which the project is to be constructed.
- 5.10 Since an ICC-ES acceptance criteria for evaluating data to determine the performance of anchors subjected to fatigue or shock loading is unavailable at this time, the use of these anchors under such conditions is beyond the scope of this report.
- 5.11 Anchors may be installed in regions of concrete where cracking has occurred or where analysis indicates cracking may occur ($f_t > f_r$), subject to the conditions of this report.
- 5.12 The anchors may be used to resist short-term loading due to wind or seismic forces in locations designated as Seismic Design Categories A through F, under the IBC, subject to the conditions of this report.
- 5.13 Where not otherwise prohibited in the code, Power-Bolt+ heavy duty sleeve anchors are permitted for use with fire-resistance-rated construction provided that at least one of the following conditions is fulfilled:
- The anchors are used to resist wind or seismic forces only.
 - Anchors that support a fire-resistance-rated envelope or a fire-resistance-rated membrane are protected by approved fire-resistance-rated materials, or have been evaluated for resistance to fire exposure in accordance with recognized standards.
 - Anchors are used to support nonstructural elements.
- 5.14 Use of carbon steel anchors is limited to dry, interior locations.
- 5.15 Special inspection must be provided in accordance with Section 4.4 of this report.
- 5.16 Anchors are manufactured under an approved quality-control program with inspections by ICC-ES.

6.0 EVIDENCE SUBMITTED

- 6.1 Data in accordance with the [ICC-ES Acceptance Criteria for Mechanical Anchors in Concrete Elements \(AC193\)](#), dated October 2017, (editorially revised December 2020), which incorporate requirements in ACI 355.2 (-19 and -07), for use in cracked and uncracked concrete; including optional service-condition Test No. 18 and Test No. 19 (AC193, Annex 1, Table 4.2) for seismic tension and shear.
- 6.2 Quality-control documentation.

7.0 IDENTIFICATION

- 7.1 The Power-Bolt+ heavy duty sleeve anchors are identified by dimensional characteristics and packaging. A length letter code is stamped on each bolt head along with the letters "PB," and these are visible after installation. [Table 2](#) summarizes the length code identification system. A plus sign "+" also appears with the letters "PB" on all anchors. Packages are identified with the product name, type and size, the company name (DEWALT), and the evaluation report number (ESR-3260).
- 7.2 The report holder's contact information is the following:

DEWALT
701 EAST JOPPA ROAD
TOWSON, MARYLAND 21286
(800) 524-3244
www.DEWALT.com
anchors@DEWALT.com

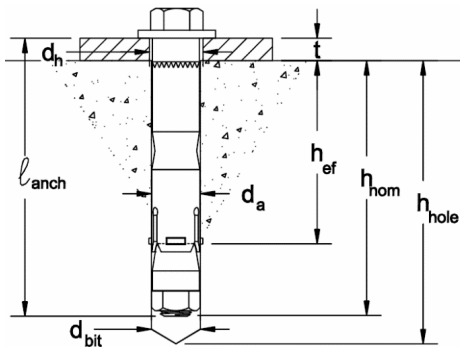

FIGURE 1—POWER BOLT +ANCHOR DETAIL

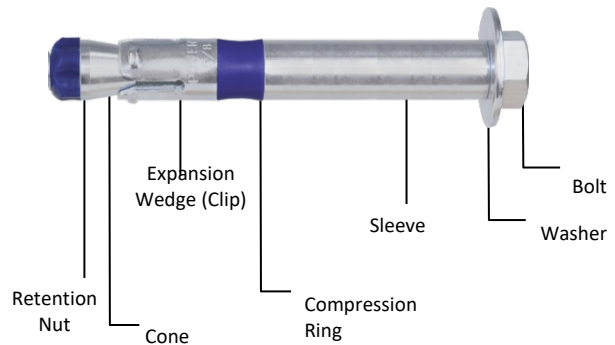

FIGURE 2—POWER BOLT+ ANCHOR ASSEMBLY

TABLE 1—POWER-BOLT+ ANCHOR INSTALLATION SPECIFICATIONS AND SUPPLEMENTAL INFORMATION^{1,3}

Anchor Property / Setting Information	Notation	Units	Nominal Anchor Diameter			
			1/2-inch	5/8-inch	3/4-inch	
Anchor diameter	d_a	in. (mm)	0.500 (12.7)	0.625 (15.9)	0.750 (19.1)	
Internal bolt diameter (UNC)	-	in. (mm)	3/8 (9.5)	7/16 (11.1)	9/16 (14.3)	
Minimum diameter of hole clearance in fixture	d_h	in. (mm)	9/16 (14.3)	11/16 (17.5)	13/16 (21.6)	
Nominal drill bit diameter (ANSI)	d_{bit}	in.	1/2	5/8	3/4	
Minimum nominal embedment depth	h_{nom}	in. (mm)	3 1/4 (83)	3 3/4 (95)	4 3/8 (111)	
Effective embedment depth	h_{ef}	in. (mm)	2 5/8 (67)	3 (76)	3 1/2 (89)	
Minimum hole depth	h_{hole}	in. mm	3 3/4 (95)	4 1/4 (108)	5 (127)	
Minimum member thickness	h_{min}	in. (mm)	5 (127)	6 1/2 (165)	7 (178)	
Minimum overall anchor length ²	l_{anch}	in. (mm)	3 1/2 (89)	4 (102)	5 1/4 (133)	
Minimum edge distance	c_{min}	in. (mm)	3 1/4 (83)	4 1/2 (114)	6 (152) 8 (203)	
Minimum spacing distance	s_{min}	in. (mm)	4 1/2 (114)	6 (152)	6 (152) 5 (127)	
Installation torque	T_{inst}	ft.-lbf. (N-m)	40 (54)	60 (81)	110 (149)	
Torque wrench/socket size	-	in.	5/8	3/4	15/16	
Bolt head height	-	in.	9/32	5/16	3/8	
Effective tensile stress area (internal bolt)	$A_{se,N}$	in. ² (mm ²)	0.0775 (50.0)	0.1063 (68.6)	0.182 (117.4)	
Effective shear stress area	$A_{se,V}$	in. ² (mm ²)	0.1069 (69.0)	0.1452 (93.7)	0.241 (153.0)	
Minimum specified ultimate tensile strength	f_{uta}	psi (N/mm ²)	150,000 (1,034)	150,000 (1,034)	150,000 (1,034)	
Minimum specified yield strength	f_{ya}	psi (N/mm ²)	130,000 (896)	130,000 (896)	130,000 (896)	
Mean axial stiffness ⁴	Uncracked concrete	β_{uncr}	lbf/in. (kN/mm)	366,000 (63)	871,000 (150)	256,000 (44)
	Cracked concrete	β_{cr}	lbf/in. (kN/mm)	64,000 (11)	94,000 (16)	27,000 (5)

For SI: 1 inch = 25.4 mm, 1 ft-lbf = 1.356 N-m.

¹The information presented in this table is to be used in conjunction with the design criteria of ACI 318 (-19 or -14) Chapter 17 or ACI 318-11 Appendix D, as applicable.

²The listed minimum overall anchor length is based on anchor sizes commercially available at the time of publication compared with the requirements to achieve the minimum nominal embedment depth and possible fixture attachment.

³The maximum fixture thickness, t_{max} for the selected anchor can be determined by taking the length of the selected anchor and subtracting the nominal embedment into the base material.

⁴Mean values shown, actual stiffness varies considerable depending on concrete strength, loading and geometry of application.

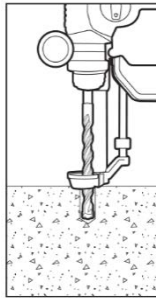

1.) Using the proper drill bit size, drill a hole into the base material to the required depth. The tolerances of the drill bit used should meet the requirements of ANSI Standard B212.15.

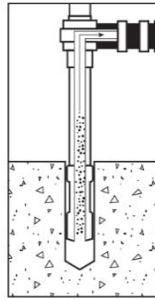

2.) Remove dust and debris from the hole during drilling (e.g. dust extractor, hollow bit) or following drilling (e.g. suction, forced air) to extract loose particles left from drilling.

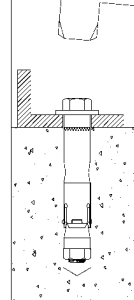



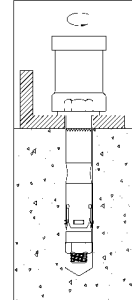



3.) Drive anchor through the fixture into the hole. Be sure the anchor is driven to the minimum required embedment depth, h_{nom} .



4.) Tighten the anchor with a torque wrench by applying the required installation torque, T_{inst} . (See [Table 1.](#))

FIGURE 3—POWER-BOLT+ INSTALLATION INSTRUCTIONS

DeWALT Dust Removal Drilling Systems with HEPA Dust Extractor Options		
Tool	Accessories and Shrouds	HEPA Dust Extractor
SDS-Max Drills		
 Cordless  Corded	 SDS-Max Hollow Drill Bit	 Dust Extractor
	 SDS-Max With Shroud	
SDS-Plus Drills		
 Cordless  Corded	 SDS-Plus Bit	 Cordless Dust Extractor
	 SDS-Plus Hollow Drill Bit	
	 SDS-Plus With Telescope	
	 SDS-Plus With Shroud	

The DEWALT drilling systems shown below collect and remove dust with a HEPA dust extractor during the hole drilling operation in dry base materials using hammer-drills (see step 1 of the manufacturer’s published installation instructions).

FIGURE 4—EXAMPLES OF DEWALT DUST REMOVAL DRILLING SYSTEMS WITH HEPA DUST EXTRACTORS FOR ILLUSTRATION

TABLE 2—POWER-BOLT+ ANCHOR LENGTH CODE IDENTIFICATION SYSTEM

Length ID marking on bolt head		A	B	C	D	E	F	G	H	I	J	K	L	M	N	O	P	Q	R	S	T
Overall anchor length, l_{anch} (inches)	From	1 1/2	2	2 1/2	3	3 1/2	4	4 1/2	5	5 1/2	6	6 1/2	7	7 1/2	8	8 1/2	9	9 1/2	10	11	12
	Up to but not including	2	2 1/2	3	3 1/2	4	4 1/2	5	5 1/2	6	6 1/2	7	7 1/2	8	8 1/2	9	9 1/2	10	11	12	13

For SI: 1 inch = 25.4 mm.

TABLE 3—TENSION DESIGN INFORMATION FOR POWER-BOLT+ ANCHOR IN CONCRETE^{1,2}

Design Characteristic	Notation	Units	Nominal Anchor Diameter		
			1/2-inch	5/8-inch	3/4-inch
Anchor category	1, 2 or 3	-	1	1	1
STEEL STRENGTH IN TENSION (ACI 318-19 17.6.1, ACI 318-14 17.4.1 or ACI 318-11 D.5.1)					
Steel strength in tension ⁸	N_{sa}	lb (kN)	9,685 (43.1)	13,285 (59.1)	27,300 (121.4)
Reduction factor for steel strength ³	ϕ	-	0.75		0.65
CONCRETE BREAKOUT STRENGTH IN TENSION (ACI 318-19 17.6.2, ACI 318-14 17.4.2 or ACI 318-11 D.5.2)⁷					
Effective embedment	h_{ef}	in. (mm)	2.625 (67)	3.00 (76)	3.50 (89)
Effectiveness factor for uncracked concrete	k_{uncr}	-	27	27	24
Effectiveness factor for cracked concrete	k_{cr}	-	17	17	17
Modification factor for cracked and uncracked concrete ⁴	$\Psi_{c,N}$	-	1.0 (see note 4)	1.0(see note 4)	1.0 (see note 4)
Critical edge distance (uncracked concrete only)	c_{ac}	in. (mm)	8 (203)	6 (152)	8 (203)
Reduction factor for concrete breakout strength ³	ϕ	-	0.65 (Condition B)		
PULLOUT STRENGTH IN TENSION (ACI 318-19 17.6.3, ACI 318-14 17.4.3 or ACI 318-11 D.5.3)⁷					
Characteristic pullout strength, uncracked concrete (2,500 psi) ⁵	$N_{p,uncr}$	lb (kN)	Not Applicable ⁶	Not Applicable ⁶	Not Applicable ⁶
Characteristic pullout strength, cracked concrete (2,500 psi) ⁵	$N_{p,cr}$	lb (kN)	Not Applicable ⁶	Not Applicable ⁶	Not Applicable ⁶
PULLOUT STRENGTH IN TENSION FOR SEISMIC APPLICATIONS (ACI 318-19 17.10.3, ACI 318-14 17.2.3.3 or ACI 318-11 D.3.3.3)⁷					
Characteristic pullout strength, seismic (2,500 psi) ⁵	$N_{p,eq}$	lb (kN)	Not Applicable ⁶	Not Applicable ⁶	Not Applicable ⁶

For SI: 1 inch = 25.4 mm; 1 ksi = 6.894 N/mm²; 1 lbf = 0.0044 kN.

¹The data in this table is intended to be used with the design provisions of ACI 318 (-19 or -14) Chapter 17 or ACI 318-11 Appendix D, as applicable; for anchors resisting seismic load combinations the additional requirements of ACI 318-19 17.10, ACI 318-14 17.2.3 or ACI 318-11 D.3.3, as applicable, shall apply.

²Installation must comply with the manufacturer’s published installation instructions.

³The strength reduction factor applies when the load combinations from the IBC or ACI 318 are used and the requirements of ACI 318-19 17.5.3, ACI 318-14 17.3.3 or ACI 318-11 D.4.3, as applicable, are met. If the load combinations of ACI 318-11 Appendix C are used, the appropriate strength reduction factor must be determined in accordance with ACI 318-11 D.4.4. The anchors are ductile steel elements as defined in ACI 318-14 2.3 or ACI 318-11 D.1, as applicable, except for the 3/4-inch-diameter, which is considered a brittle steel element for the purposes of design.

⁴For all design cases use $\Psi_{c,N} = 1.0$. The appropriate effectiveness factor for cracked concrete (k_{cr}) or uncracked concrete (k_{uncr}) must be used.

⁵For all design cases use $\Psi_{c,P} = 1.0$. For the calculation of N_{pn} , see Section 4.1.4 of this report.

⁶Pullout strength does not control design of the indicated anchors and does not need to be calculated for indicated size and embedment.

⁷Anchors are permitted to be used in lightweight concrete in accordance with Section 4.1.12 of this report.

⁸In accordance with ACI 318-19 17.6.1.2 and Eq. 17.6.1.2, ACI 318-14 17.4.1.2 and Eq. 17.4.1.2 or ACI 318-11 D.5.1.2 and Eq. D-2, as applicable, the nominal steel strength in tension is calculated using a limited value of f_{uta} of 125 ksi.

TABLE 4—SHEAR DESIGN INFORMATION FOR POWER-BOLT+ ANCHOR IN CONCRETE^{1,2}

Design Characteristic	Notation	Units	Nominal Anchor Diameter		
			1/2-inch	5/8-inch	3/4-inch
Anchor category	1, 2 or 3	-	1	1	1
STEEL STRENGTH IN SHEAR (ACI 318-19 17.7.1, ACI 318-14 17.5.1 or ACI 318-11 D6.1)					
Steel strength in shear ⁵	V_{sa}	lb (kN)	6,005 (26.7)	13,415 (59.7)	14,820 (65.9)
Reduction factor for steel strength ³	ϕ	-	0.65		0.60
STEEL STRENGTH IN SHEAR FOR SEISMIC APPLICATIONS (ACI 318-19 17.10.3, ACI 318-14 17.2.3.3 or ACI 318-11 D.3.3.3)					
Steel strength in shear, seismic ⁵	$V_{sa,eq}$	lb (kN)	4,565 (20.3)	7,425 (33.0)	14,820 (65.9)
Reduction factor for steel strength in shear for seismic ³	ϕ	-	0.65		0.60
CONCRETE BREAKOUT STRENGTH IN SHEAR (ACI 318-19 17.7.2, ACI 318-14 17.5.2 or ACI 318-11 D6.2)⁴					
Load bearing length of anchor	ℓ_e	in. (mm)	1.00 (25)	1.25 (32)	1.5 (38)
Nominal anchor diameter	d_a	in. (mm)	0.500 (12.7)	0.625 (15.9)	0.750 (19.1)
Reduction factor for concrete breakout ³	ϕ	-	0.70 (Condition B)		
PRYOUT STRENGTH IN SHEAR (ACI 318-19 17.7.3, ACI 318-14 17.5.3 or ACI 318-11 D.6.3)⁴					
Coefficient for prying strength	k_{cp}	-	2.0	2.0	2.0
Effective embedment	h_{ef}	in. (mm)	2.625 (67)	3.000 (76)	3.500 (89)
Reduction factor for prying strength ³	ϕ	-	0.70 (Condition B)		

For **SI**: 1 inch = 25.4 mm; 1 ksi = 6.894 N/mm²; 1 lbf = 0.0044 kN.

¹The data in this table is intended to be used with the design provisions of ACI 318 (-19 or -14) Chapter 17 or ACI 318-11 Appendix D, as applicable; for anchors resisting seismic load combinations the additional requirements of ACI 318-19 17.10, ACI 318-14 17.2.3 or ACI 318-11 D.3.3, as applicable, shall apply.

²Installation must comply with the manufacturer's published installation instructions.

³The strength reduction factor applies when the load combinations from the IBC or ACI 318 are used and the requirements of ACI 318-19 17.5.3, ACI 318-14 17.3.3 or ACI 318-11 D.4.3, as applicable, are met. If the load combinations of ACI 318-11 Appendix C are used, the appropriate strength reduction factor must be determined in accordance with ACI 318-11 D.4.4. The anchors are ductile steel elements as defined in ACI 318-14 2.3 or ACI 318-11 D.1, as applicable, except for the 3/4-inch-diameter which is considered a brittle steel element for the purposes of design..

⁴Anchors are permitted to be used in lightweight concrete in accordance with Section 4.1.12 of this report.

⁵Tabulated values for steel strength in shear, including values listed for seismic applications, are based on test results in accordance with ACI 355.2.

TABLE 5—EXAMPLE ALLOWABLE STRESS DESIGN VALUES FOR ILLUSTRATIVE PURPOSES^{1,2,3,4,5,6,7,8,9}

Anchor Diameter (inches)	Nominal Embedment Depth (inches)	Effective Embedment (inches)	Allowable Tension Load (pounds)
1/2	3 1/4	2 5/8	2,520
5/8	3 3/4	3	3,080
3/4	4 3/8	3 1/2	3,450

For **SI**: 1 inch = 25.4 mm, 1 lbf = 4.45 N.

¹Single anchor with static tension load only.

²Concrete determined to remain uncracked for the life of the anchorage.

³Load combinations are taken from ACI 318 (-19 or -14) Section 5.3 or ACI 318-11 Section 9.2, as applicable, (no seismic loading).

⁴30% dead load and 70% live load, controlling load combination 1.2D + 1.6L.

⁵Calculation of weighted average for conversion factor $\alpha = 1.2(0.3) + 1.6(0.7) = 1.48$.

⁶ $f'_c = 2,500$ psi (normal weight concrete).

⁷ $C_{a1} = C_{a2} \geq C_{ac}$.

⁸ $h \geq h_{min}$.

⁹Values are for Condition B where supplementary reinforcement in accordance with ACI 318-19 17.5.3, ACI 318-14 17.3.3 or ACI 318-11 D.4.3, as applicable, is not provided.

DIVISION: 03 00 00—CONCRETE**Section: 03 16 00—Concrete Anchors****DIVISION: 05 00 00—METALS****Section: 05 05 19—Post-Installed Concrete Anchors****REPORT HOLDER:**

DEWALT

EVALUATION SUBJECT:**POWER-BOLT®+ HEAVY DUTY SLEEVE ANCHORS FOR CRACKED AND UNCRACKED CONCRETE (DEWALT)****1.0 REPORT PURPOSE AND SCOPE****Purpose:**

The purpose of this evaluation report supplement is to indicate that Power-Bolt+ Heavy Duty Sleeve Anchors for cracked and uncracked concrete, described in ICC-ES evaluation report [ESR-3260](#), have also been evaluated for compliance with the codes noted below as adopted by the Los Angeles Department of Building and Safety (LADBS).

Applicable code editions:

- 2020 *City of Los Angeles Building Code* (LABC)
- 2020 *City of Los Angeles Residential Code* (LARC)

2.0 CONCLUSIONS

The Power-Bolt+ Heavy Duty Sleeve Anchors for cracked and uncracked concrete, described in Sections 2.0 through 7.0 of the evaluation report [ESR-3260](#), comply with LABC Chapter 19, and LARC, and are subjected to the conditions of use described in this supplement.

3.0 CONDITIONS OF USE

The Power-Bolt+ Heavy Duty Sleeve Anchors described in this evaluation report supplement must comply with all of the following conditions:

- All applicable sections in the evaluation report [ESR-3260](#).
- The design, installation, conditions of use and identification of the anchors are in accordance with the 2018 *International Building Code*® (IBC) provisions noted in the evaluation report [ESR-3260](#).
- The design, installation and inspection are in accordance with additional requirements of LABC Chapters 16 and 17, as applicable.
- Under the LARC, an engineered design in accordance with LARC Section R301.1.3 must be submitted.
- The allowable and strength design values listed in the evaluation report and tables, are for the connection of the anchors to the concrete. The connection between the anchors and the connected members shall be checked for capacity (which may govern).
- For use in wall anchorage assemblies to flexible diaphragm applications, anchors shall be designed per the requirements of City of Los Angeles Information Bulletin P/BC 2020-071.

This supplement expires concurrently with the evaluation report, reissued November 2023.